

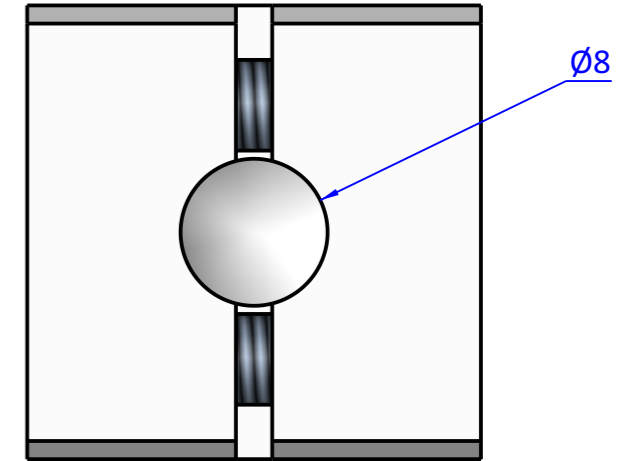

Item	Name	Q.ty
1	03.11.002	1
2	V.TCE5x20	3

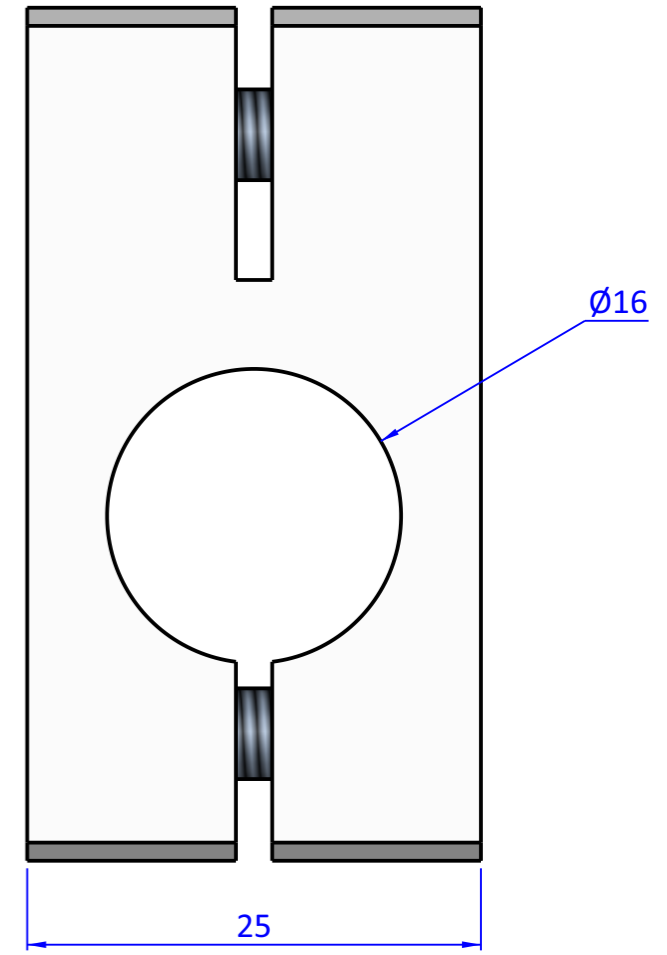
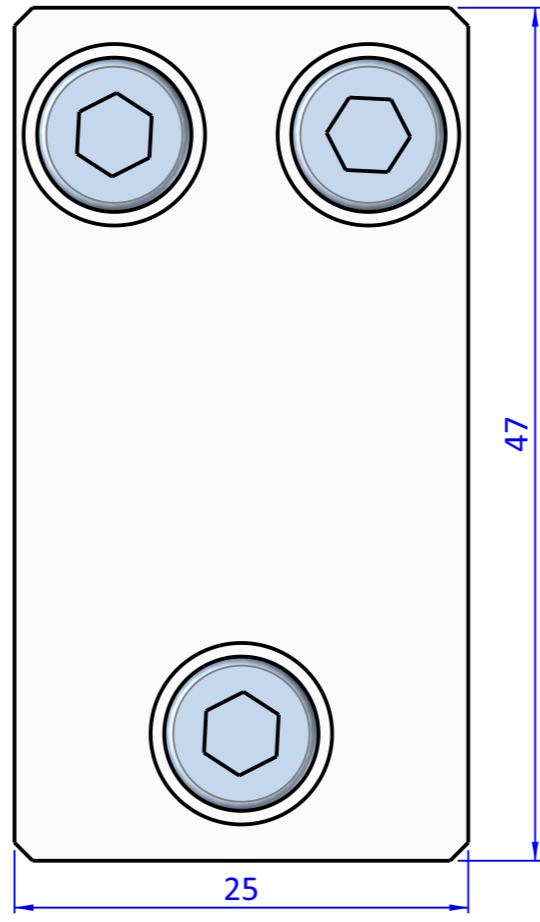
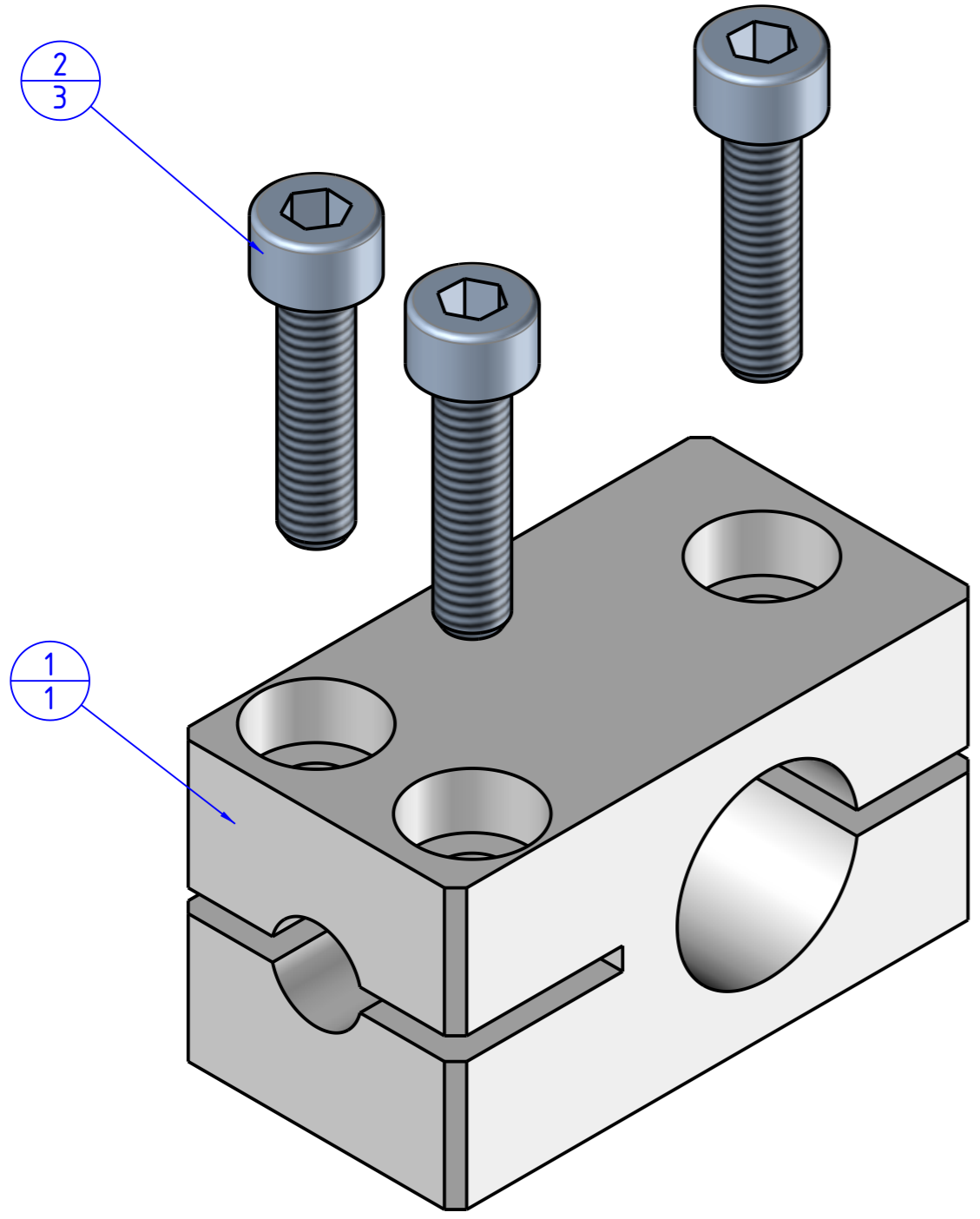

THE PROPERTY OF THE DRAWING IS ESTABLISHED BY LAW. IT IS FORBIDDEN TO PRODUCE OR SHOW IT TO THIRD PART, WITHOUT A WRITTEN AGREEMENT.

Format A3
UNI 936-76

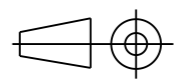
 FPS FPSERVICES AUTOMATION			DESIGNED FROM FPS Automation	REVIEW A
GENERAL TOLERANCE UNI - ISO 2768 CLASSE f	DESCRIPTION CA.03.11.002	DATE 13/12/2023	WEIGHT 0,069kg	CODE CA.03.11.002